

Slip Ring Assemblies

Program 5100



CONDUCTIX
wampfler

Contents

General

Electrical Data.....	5
Program Overview.....	5
Example of a Combined Slip Ring Assembly.....	6
A Developed and Comprehensive Standard Program	7

Slip Ring Assemblies

Built-in Slip Ring Assembly ES30 16 A ¹⁾ /415 V (400 V) ²⁾	8
Encapsulated Slip Ring Assembly GS30 16 A ¹⁾ /415V (400V) ²⁾	8
Built-in Slip Ring Assembly ES45/1 21 A (28 A) ¹⁾ /415 V (400 V) ²⁾	9
Encapsulated Slip Ring Assembly GS45/1 21 A (28 A) ¹⁾ / 415V (400V) ²⁾	9
Built-in Slip Ring Assembly ES45/3 21 A (28 A) ¹⁾ /690 V (630 V) ²⁾	10
Encapsulated Slip Ring Assembly GS45 / 3 21 A (28 A) ¹⁾ / 690V (630V) ²⁾	10
Built-in Slip Ring Assembly ES45/2 47 A ¹⁾ /690V (630V) ²⁾	11
Encapsulated Slip Ring Assembly GS45/2 47 A ¹⁾ /690V (630V) ²⁾	11
Built-in Slip Ring Assembly ES18 21 A ¹⁾ /690V (630V) ²⁾	12
Encapsulated Slip Ring Assembly GS18 21 A ¹⁾ /690V (630V) ²⁾	13
Built-in Slip Ring Assembly ES13 50 A ¹⁾ /690V (630V) ²⁾	14
Encapsulated Slip Ring Assembly GS13 50 A ¹⁾ /690V (630V) ²⁾	14
Built-in Slip Ring Assembly ES15 70 A (90 A) ¹⁾ / 690V (630V) ²⁾	15
Encapsulated Slip Ring Assembly GS15 70 A (90 A) ¹⁾ /690V (630V) ²⁾	15
Built-in Slip Ring Assembly ES16 100 A ¹⁾ /750 V ^{2) 5)}	16
Encapsulated Slip Ring Assembly GS16 100 A ¹⁾ /750 V ^{2) 5)}	16
Built-in Slip Ring Assembly ES19 150 A ¹⁾ /750 V ^{2) 5)}	17
Encapsulated Slip Ring Assembly GS19 150 A ¹⁾ /750 V ^{2) 5)}	17
Built-in Slip Ring Assembly ES21 250 A ¹⁾ /750 V ^{2) 5)}	18
Encapsulated Slip Ring Assembly GS21 250 A ¹⁾ /750 V ^{2) 5)}	18
Built-in Slip Ring Assembly ES29 400 A ¹⁾ /750 V ^{2) 5)}	19
Encapsulated Slip Ring Assembly GS29 400 A ¹⁾ /750 V ^{2) 5)}	19
Built-in Slip Ring Assembly ES260 47 A ¹⁾ /690V (630V) ^{2) 5)}	20
Encapsulated Slip Ring Assembly GS260 47 A ¹⁾ /690V (630V) ^{2) 5)}	20
Built-in Slip Ring Assembly ES170, ES200, ES285 47 A ¹⁾ /690V (630V) ^{2) 5)}	21

Combined Slip Ring Assemblies

Encapsulated Slip Ring Assembly GS323 400 A ¹⁾ /750 V ⁵⁾	23
Encapsulated Slip Ring Assembly e.g. type GS19/13/18	24
Encapsulated Slip Ring Assembly combined with rotary transmitters for gases and fluids	25

¹⁾ The information on current carrying capacity refers to individual slip rings including current collectors. The actual current carrying capacity of the complete slip ring assembly (indicated on the nameplate) may differ significantly depending on the prevailing conditions (e.g. number of slip rings, conductivity type, ambient temperature). The corresponding conversion factors for current carrying capacity according to DIN VDE 0298-4 must be taken into account.

²⁾ The voltages apply to slip ring assemblies which are used in systems or system parts supplied directly from the low-voltage network (VDE 0110-1/2008-01: 4.3.2.2.1, Table F.3b). When used in systems or system components that are not directly supplied by the low-voltage network, only the bracket values are permitted (VDE 0110-1/2008-01: 4.3.2.2.2, Table F.4).

⁵⁾ 1000 V on request

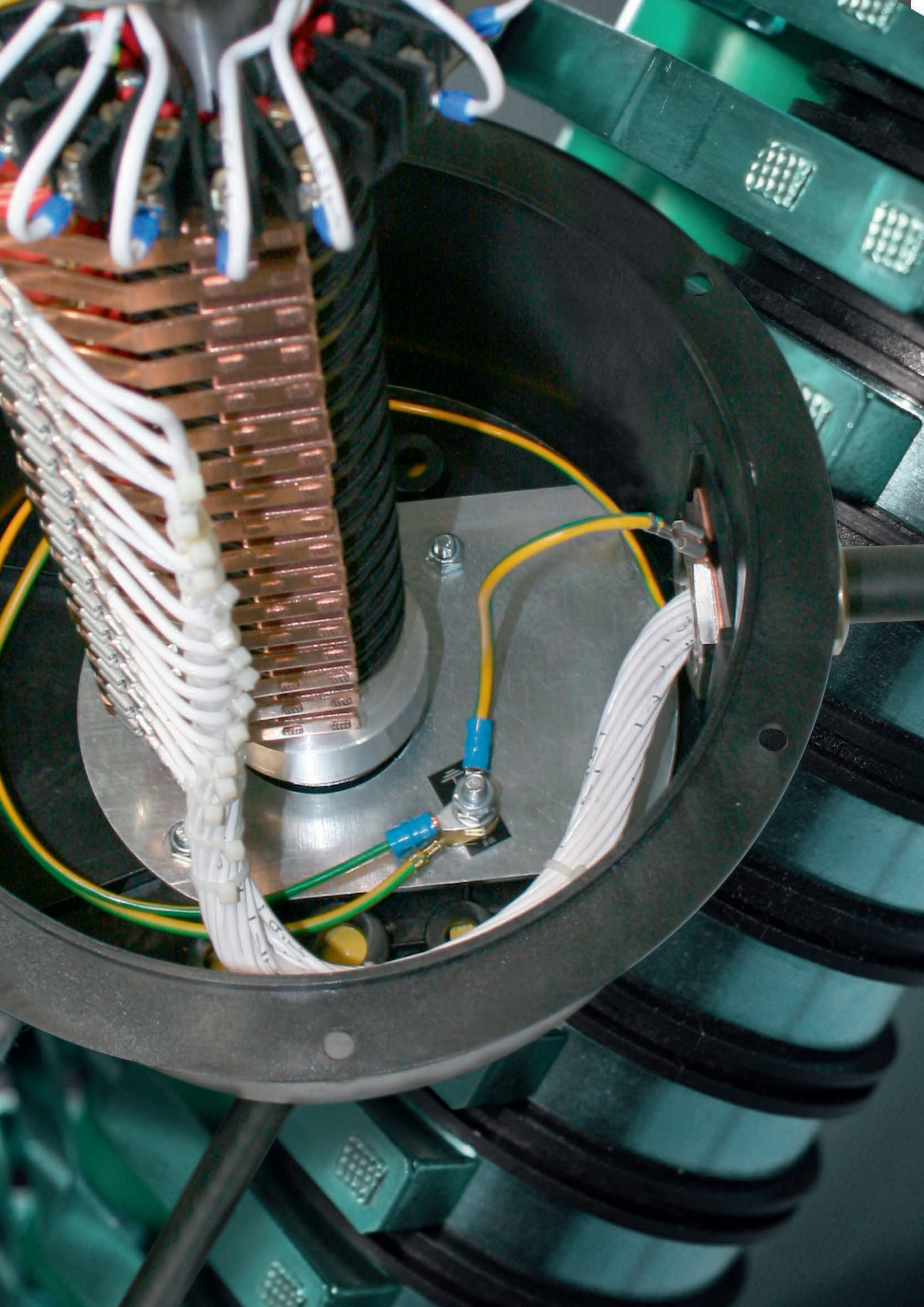

General

Electrical Data

Conductix-Wampfler - an expert partner

Conductix-Wampfler offers a wide range of rotary transmitters for the transmission of energy, data and signals and for the transmission of gaseous and liquid media. The standard program makes it possible to combine slip ring assemblies for energy and data/signal currents in any number of poles. Combinations with additional rotary transmitters for liquid media (water, hydraulic oil, oil, etc.) and gases (compressed air, argon, etc.) are possible. Slip ring assemblies can be supplied both as open built-in slip ring assemblies for customer integration, as well as with housings made of impact-resistant plastic or steel.

Data transmission

The transmission of analog and digital signals is standard and is used in both industrial applications and many other applications. Communication takes place via all current transmission protocols. Slip ring assemblies made of different materials are used depending on the application.

Note: The quality of the transmission of the analog and digital signals depends strongly on the structure of the overall system. The supply lines used, their installation and shielding, the number of line connections, outside interference, the type of transmission components and their adaptation to each other play an essential role. All of these must be taken into account when designing the overall system.

Options

- Ventilation screws
- Cable glands
- Tube feedthroughs
- Rotary feedthroughs
- Reinforced bearings
- Stainless steel housing
- Special paints for corrosion protection up to C5M
- Terminal boxes
- Heaters
- Mounting of rotary encoders (encoders and potentiometers)
- Windows and doors for large slip ring assembly housings

Special versions

We would be happy to advise you if you have special requirements. For example: Diameter > 10 m, high rotational speeds, extreme operating conditions, fiber optic cables, medium voltage, data rates up to 1 Gbit, etc.

Easy to install and maintain

Our slip ring assemblies are characterized by their easy installation and maintenance. On request, rings and current collectors can be completely pre-wired to mounted terminal boxes. The connections are easily accessible and the current collector easily replaceable.

Norms and standards

All rotary transmitters from Conductix-Wampfler are state of the art. Our products meet the strict requirements of the Low Voltage Directive, RoHS Directive and REACH Regulation.

Program Overview

Type	I ¹⁾ [mA/A]	U [V]	Ring-ø [mm]	Special feature	Page
ES/GS30	mA - 16	415 (400) ²⁾	30	Suitable for data transmission	8
ES/GS45/1	mA - 21 (28) ³⁾	415 (400) ²⁾	45		9
ES/GS45/3	21 (28) ³⁾	690	45	-	10
ES/GS45/2	47	690	45	-	11
ES18	mA - 21	690 (630) ²⁾	102	Suitable for data transmission	12
GS18	mA - 21	690 (630) ²⁾	102		13
ES/GS13	50	690	85	-	14
ES/GS15	70 (90) ⁴⁾	690	85	-	15
ES/GS16	100	750 ⁵⁾	110	-	16
ES/GS19	150	750 ⁵⁾	132	-	17
ES/GS21	250	750 ⁵⁾	210	-	18
ES/GS29	400	750	210	-	19
ES/GS260	mA - 47	690 (630) ²⁾	260	Suitable for data transmission	20
ES170, 200, 285	mA - 47	690 (630) ²⁾	170/200/285		21
GS323	400	750 ⁵⁾	320	-	23
GS19/13/18	Combination				24

¹⁾ The information on current carrying capacity refers to individual slip rings including current collectors. The actual current carrying capacity of the complete slip ring assembly (indicated on the nameplate) may differ significantly depending on the prevailing conditions (e.g. number of slip rings, conductivity type, ambient temperature). The corresponding conversion factors for current carrying capacity according to DIN VDE 0298-4 must be taken into account.

²⁾ The voltages apply to slip ring assemblies which are used in systems or system parts supplied directly from the low-voltage grid (VDE 0110-1/2008-01: 4.3.2.2.1, Table F.3b). When used in systems or system components that are not directly supplied by the low-voltage network, only the bracket values are permitted (VDE 0110-1/2008-01: 4.3.2.2.2, Table F.4).

³⁾ 28 A specially wired on request with 4 mm²

⁴⁾ 90 A specially wired on request with 25 mm²

⁵⁾ 1000 V on request

General

Example of a Combined Slip Ring Assembly

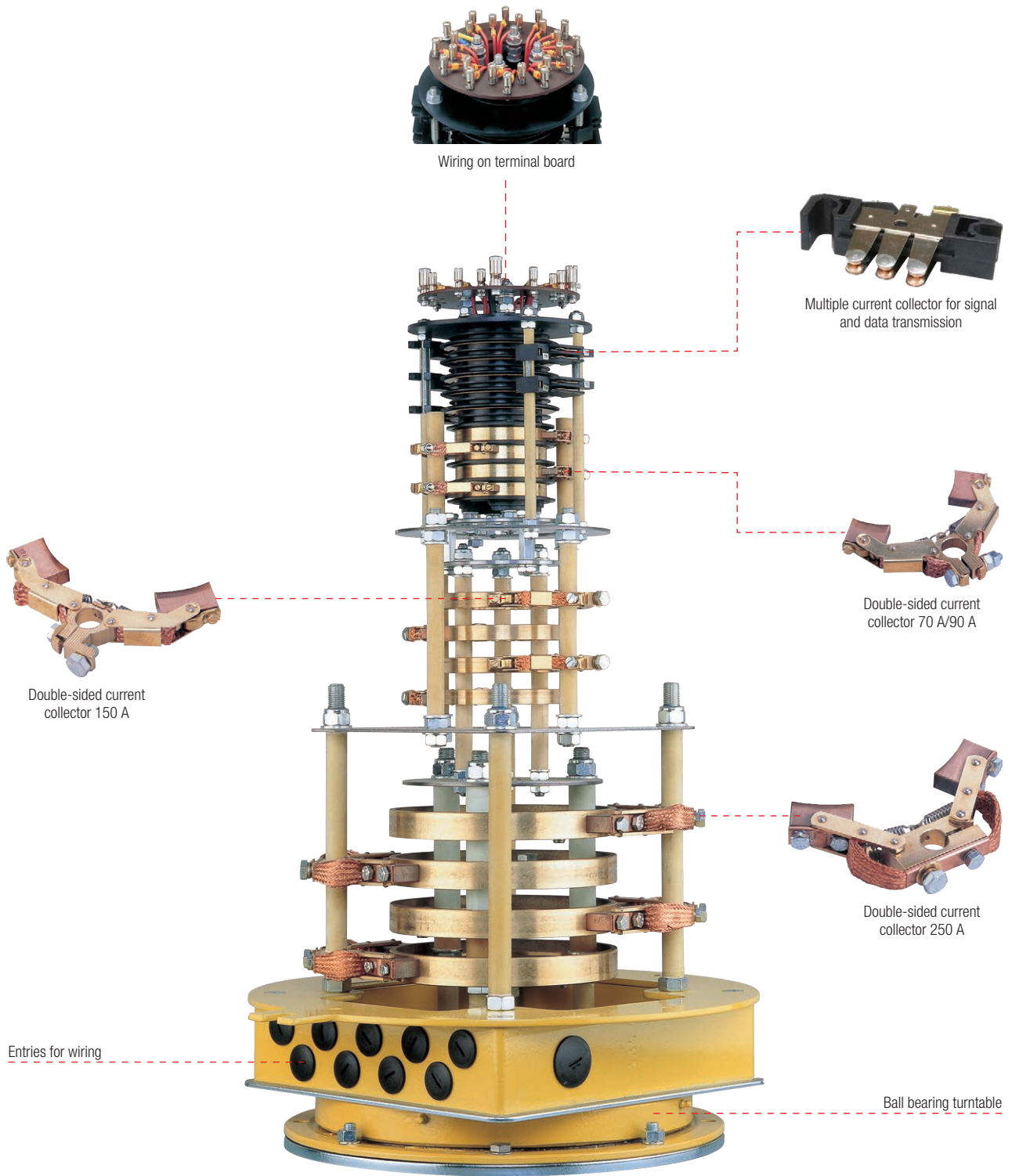

Combined Slip Ring Assembly
GS2104 / 1904 / 1504 / 1806 / 04 ML
3x250 A + PE + 4x150 A + 4x70 A/90 A + 6x21 A + 4x data

General

A Developed and Comprehensive Standard Program

Slip ring assemblies are used for example in rotary cranes, circular scrapers (sewage treatment plants), carousels, manipulators, turntables, antenna systems, theater stages, packaging machines and cable reels.



Rotary injection-molding machine from Krauss-Maffei Kunststofftechnik (Munich)



Slip ring assembly in gate locking system



Slip ring assembly in construction machine



Slip ring assembly in lift

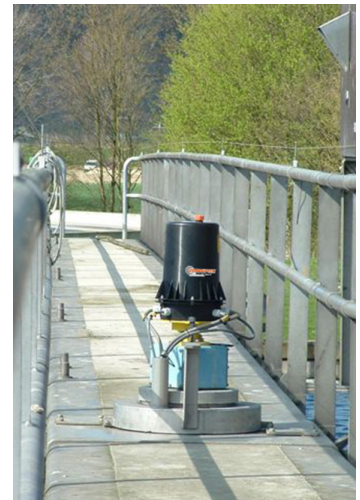

Slip ring assembly in circular scraper (sewage treatment plant)



Slip ring assembly in theater (stage floor)



Slip ring assembly in carousel



Slip ring assembly in packaging machine

Slip Ring Assembly

Built-in Slip Ring Assembly ES30 16 A¹/415 V (400 V)²



Electrical data

- Voltage:
 - Max. 415 V (400 V)² ~
 - According to DIN VDE 0110
 - Overvoltage category III
 - Contamination degree 3
- Current: mA to 16 A¹, at max. 30°C and 100% duty cycle
- Slip rings:
 - \varnothing 30 x 6 mm, brass (MS)
 - Ring distance 12 mm
- Current collector:
 - Holder with two pressed-on carbon-fiber brushes (Cu) 20 x 6.4 mm
 - Connection: Flat plug 4.8 (DIN 46244) for flat socket 4.8 (DIN 46247)
- Protection class: IP 00

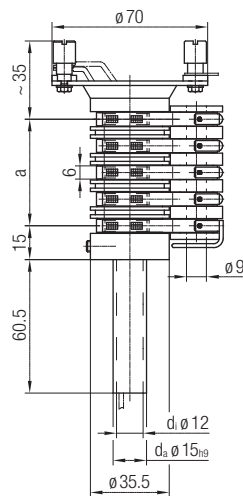

$$a = (\text{Number of poles} - 1) \times 12$$

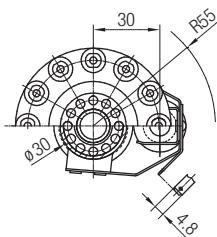

Control and data transmission

- Multi-layer coating (ML) and silver current collector (Ag) for transmission of analog and digital signals
- We ask for a separate request for transmission of indicated values and video signals

Wiring and max. number of poles

- Max. 10 (including PE)
- Completely wired with 2.5 mm² on terminal board (sheath terminals)

Further technical data

- Rotation speed: 1-100 min⁻¹ (Data: max. 30 min⁻¹)
- Ambient temperature:
 - From -30°C to max. +50°C
 - At > 30°C, the max. current load must be reduced accordingly
 - Higher temperature values on request
- Installation position: upright (other installation positions on request)
- Axle tube: $d_a = 15_{h9}$

Scope of delivery

- Slip Ring Assembly complete with current collectors
- Insulator
- Axle tube (secure against rotation on site with 2 sets of threaded pins M 5, DIN 914)
- Without brush holder bolt

²⁾ See page 5, footnote 2)

Order example:

ES30/R15-04
Built-in slip ring assembly type 30, 3-pole + PE with tube $d_a = 15_{h9}$

Encapsulated Slip Ring Assembly GS30 16 A¹/415 V (400 V)²



Electrical data

- According to type ES30
- Protection class: IP 65

Control, data transmission, wiring and max. number of poles

- According to type ES30

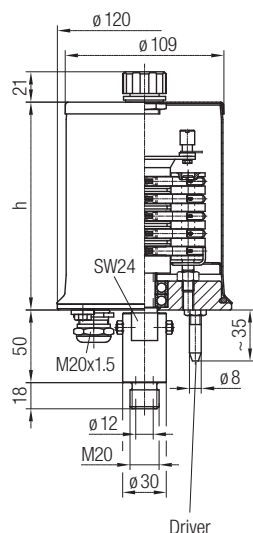

Max. number of poles incl. PE	h [mm]
4	126
6	143
10	193

Further technical data

- Rotation speed: 1-100 min⁻¹ (Data: max. 30 min⁻¹)
- Ambient temperature:
 - From -30°C to max. +50°C
 - At > 30°C, the max. current load must be reduced accordingly
 - Higher temperature values on request
- Installation position: upright (other installation positions on request)
- Bearing: Rolling bearings, lubricated for life
- Corrosion protection: Steel parts galvanized and/or powder coated RAL 1012
- Screw connections:
 - In the axle bore \varnothing 12 mm external thread M 20
 - In housing M 20 x 1.5 (on request as angle screwed connection)
- Option: with mounting flange

²⁾ See page 5, footnote 2)

Order example:

GS30-04
Encapsulated slip ring assembly type 30, 3-pole + PE

¹⁾ Note: The information on current carrying capacity refers to individual slip rings including current collectors. The actual current carrying capacity of the complete slip ring assembly may differ significantly depending on the prevailing conditions (e.g. number of slip rings, conductivity type, ambient temperature). The corresponding conversion factors for current carrying capacity according to DIN VDE 0298-4 must be taken into account.

Slip Ring Assembly

Built-in Slip Ring Assembly ES45/1 21 A (28 A)^{1) 3)}/415 V (400 V)²⁾

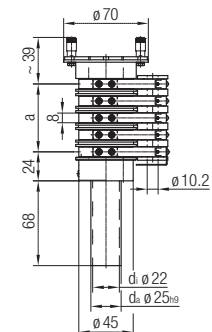

$$a = (\text{Number of poles} - 1) \times 14$$

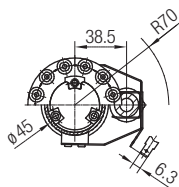

12 poles with sheath clamps

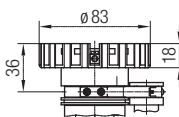

13 to 18 poles with terminal blocks

Electrical data

- Voltage:
 - Max. 415 V (400 V)^{2) ~}
 - According to DIN VDE 0110
 - Overvoltage category III
 - Contamination degree 3
- Current: 21 A (28 A)^{1) 3)}, at max. 30°C and 100% duty cycle
- Slip rings:
 - \varnothing 45 x 8 mm, brass (MS)
 - Ring distance 14 mm
- Current collector:
 - Holder with two pressed-on carbon-fiber brushes (Cu) 20 x 8 mm
 - Connection: Flat plug 6.3 (DIN 46244) for flat socket 6.3 (DIN 46247)
- Protection class: IP 00

Control and data transmission

- Multi-layer coating (ML) and silver current collector (Ag) for transmission of analog and digital signals
- We ask for a separate request for transmission of indicated values and video signals

Wiring and max. number of poles

- Up to 15 (including PE) completely wired with 4 mm² on terminal board
- Max. 18 (including PE) completely wired with 2.5 mm² on terminal board
- Up to 12 rings, connection to sheath clamps
- 13 to 18 rings connection to terminal blocks

Further technical data

- Rotation speed: 1-100 min⁻¹ (Data: max. 30 min⁻¹)
- Ambient temperature:
 - From -30°C to max. +50°C
 - At > 30°C, the max. current load must be reduced accordingly
 - Higher temperature values on request
- Installation position: upright (other mounting positions on request)
- Axle tube: $d_a = 25_{H9}$

Scope of delivery

- Slip Ring Assembly complete with current collectors
- Insulator
- Axle tube (on site with 2 sets of M5 threaded pins, DIN 914, secure against rotation)
- Without brush bolt

²⁾ See page 5, footnote 2)

³⁾ 28 A specially wired on request with 4 mm²

Order example: ES45/1/R22-04

Built-in slip ring assembly type 45/1, 3-pole + PE with tube $d_a = 25_{H9}$

Encapsulated Slip Ring Assembly GS45/1 21 A (28 A)³⁾/ 415 V (400 V)²⁾

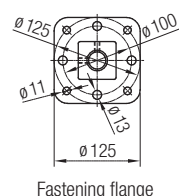
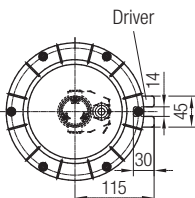
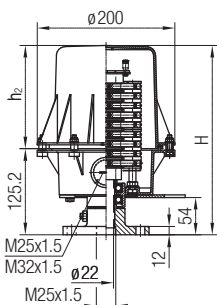

Fastening flange

Electrical data

- According to type ES45/1
- Protection class: IP 65

Control, data transmission.

Wiring and max. number of poles

- According to type ES45/1

h ₂ [mm]	H [mm]	Max. number of poles incl. PE	
		Standard	with heating
90	215	5	-
150	275	9	4
190	315	12	7
280	405	18	13

Further technical data

- Rotation speed: 1-100 min⁻¹ (Data: max 30 min⁻¹)
- Ambient temperature:
 - From -30°C to max. +50°C
 - At > 30°C, the max. current load must be reduced accordingly
 - Higher temperature values on request
- Installation position: upright (other mounting positions on request)
- Corrosion protection: Steel parts galvanized and/or powder coated RAL 1012
- Standard housing made of polyamide
- Glands:
 - Internal thread in the mounting flange for M 25 x 1.5
 - Passage holes in the lower part of the housing for M 25 x 1.5 and M 32 x 1.5

Options

- On request (see "Options", page 5)

²⁾ See page 5, footnote 2)

³⁾ 28 A specially wired on request with 4 mm²

Order example: GS45/1KS-04

Encapsulated slip ring assembly type 45/1 with plastic housing, 3-pole + PE

¹⁾ Note: The information on current carrying capacity refers to individual slip rings including current collectors. The actual current carrying capacity of the complete slip ring assembly may differ significantly depending on the prevailing conditions (e.g. number of slip rings, conductivity type, ambient temperature). The corresponding conversion factors for current carrying capacity according to DIN VDE 0298-4 must be taken into account.

Slip Ring Assembly

Built-in Slip Ring Assembly ES45/3 21 A (28 A)^{1) 3)/690 V (630 V)²⁾}



Electrical data

- Voltage:
 - Max. 690 V (630 V)^{2) ~}
 - According to DIN VDE 0110
 - Overvoltage category III
 - Contamination degree 3
- Current: 21 A (28 A)^{1) 3)}, at max. 30°C and 100% duty cycle
- Slip rings:
 - \varnothing 45 x 8 mm, brass (MS)
 - Ring distance 28 mm
- Current collector:
 - Holder with two pressed-on carbon-fiber brushes (Cu) 20 x 8 mm
 - Connection: Flat plug 6.3 (DIN 46244) for flat socket 6.3 (DIN 46247)
- Protection class: IP 00

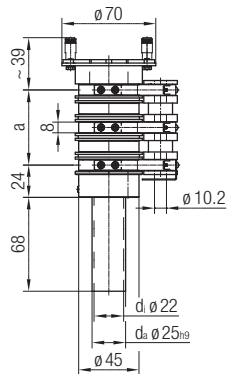

$$a = (\text{Number of poles} - 1) \times 28$$

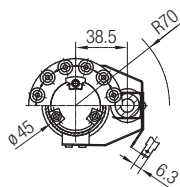

Wiring and max. number of poles

- Max. 9 (including PE)
- Completely wired with 2.5 mm² (4 mm²)²⁾ on terminal board (sheath clamps)

Further technical data

- Rotation speed: 1-100 min⁻¹
- Ambient temperature:
 - From -30°C to max. +50°C
 - At > 30°C, the max. current load must be reduced accordingly
 - Higher temperature values on request
- Installation position: upright (other installation positions on request)
- Axle tube: $d_a = 25_{H9}$

Scope of delivery

- Slip Ring Assembly complete with current collectors
- Insulator
- Axle tube (on site with 2 sets of M5 threaded pins, DIN 914, secure against rotation)
- Without brush bolt

2) See page 5, footnote 2)

3) 28 A specially wired on request with 4 mm²

Order example:

ES45/3/R22-04
Built-in slip ring assembly type 45/3; 3-pole + PE with tube $d_a = 25_{H9}$

Encapsulated Slip Ring Assembly GS45 / 3 21 A (28 A)^{3)/ 690 V (630 V)²⁾}



Electrical data

- According to type ES45/3
- Protection class: IP 65

Control, data transmission.

Wiring and max. number of poles

- According to type ES45/3

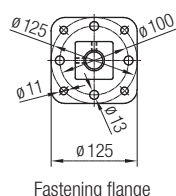
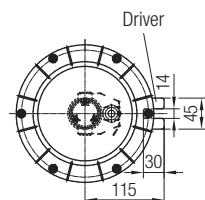
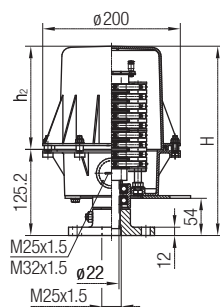

h_2 [mm]	H [mm]	Max. number of poles incl. PE	
		Standard	with heating
90	215	3	-
150	275	5	2
190	315	6	4
280	405	9	7

Further technical data

- Rotation speed: 1-100 min⁻¹
- Ambient temperature:
 - From -30°C to max. +50°C
 - At > 30°C, the max. current load must be reduced accordingly
 - Higher temperature values on request
- Installation position: upright (other mounting positions on request)
- Corrosion protection: Steel parts galvanized and/or powder coated RAL 1012
- Standard housing made of polyamide
- Glands:
 - Internal thread in the mounting flange for M 25 x 1.5
 - Passage holes in the lower part of the housing for M 25 x 1.5 and M 32 x 1.5

Options

- On request (see "Options", page 5)

2) See page 5, footnote 2)

3) 28 A specially wired on request with 4 mm²

Order example:

GS45/3KS-04
Encapsulated slip ring assembly type 45/3 with plastic housing, 3-pole + PE

¹⁾ Note: The information on current carrying capacity refers to individual slip rings including current collectors. The actual current carrying capacity of the complete slip ring assembly may differ significantly depending on the prevailing conditions (e.g. number of slip rings, conductivity type, ambient temperature). The corresponding conversion factors for current carrying capacity according to DIN VDE 0298-4 must be taken into account.

Slip Ring Assembly

Built-in Slip Ring Assembly ES45/2 47 A¹⁾/690 V (630 V)²⁾

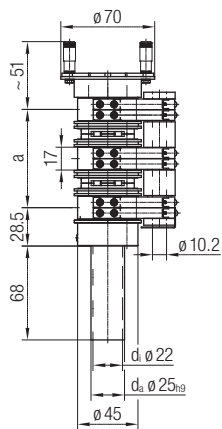

$$a = (\text{Number of poles} - 1) \times 36.6$$

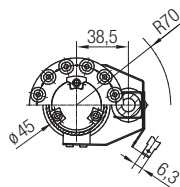

Electrical data

- Voltage:
 - Max. 690 V (630 V)²⁾~
 - According to DIN VDE 0110
 - Overvoltage category III
 - Contamination degree 3
- Current: 47 A¹⁾, at max. 30°C and 100% duty cycle
- Slip rings:
 - \varnothing 45 x 17 mm, brass (MS)
 - Ring distance 36.6 mm
- Current collector:
 - Two current collectors per slip ring with two pressed-on carbon-fiber brushes (Cu) 20 x 8 mm
 - Connection: Flat plug 6.3 (DIN 46244) for flat socket 6.3 (DIN 46247)
- Protection class: IP 00

Wiring and max. number of poles

- Max. 5 (including PE)
- Completely wired with 10 mm² on terminal board (sheath terminals)
- Current collector per ring in pairs on terminals

Further technical data

- Rotation speed: 1-100 min⁻¹
- Ambient temperature:
 - From -20°C to max. +50°C
 - At > 30°C, the max. current load must be reduced accordingly
 - Higher temperature values on request
- Installation position: upright (other installation positions on request)
- Axle tube: $d_a = 25_{H9}$

Scope of delivery

- Slip Ring Assembly complete with current collectors
- Insulator
- Axle tube (on site with 2 sets of M5 threaded pins, DIN 914, secure against rotation)
- Without brush bolt

Installation instructions

The two current collectors per ring must always be connected in parallel to a terminal strip or similar.

²⁾ See page 5, footnote 2)

Order example:

ES45/2/R22-04
Built-in slip ring assembly type 45/2, 3-pole + PE with tube $d_a = 25_{H9}$

Encapsulated Slip Ring Assembly GS45/2 47 A¹⁾/690 V (630 V)²⁾

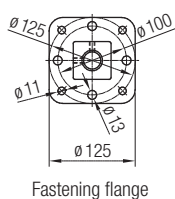
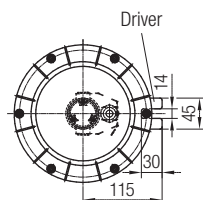
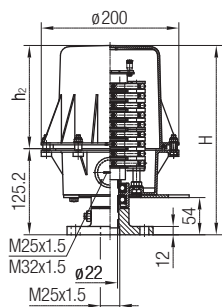

Electrical data

- According to type ES45/2
- Protection class: IP 65

Control, data transmission.

Wiring and max. number of poles

- According to type ES45/2

h ₂ [mm]	H [mm]	Max. number of poles incl. PE	
		Standard	with heating
90	215	2	-
150	275	3	-
190	315	5	3
280	405	-	5

Further technical data

- Rotation speed: 1-100 min⁻¹
- Ambient temperature:
 - From -20°C to max. +50°C
 - At > 30°C, the max. current load must be reduced accordingly
 - Higher temperature values on request
- Installation position: upright (other installation positions on request)
- Corrosion protection: Steel parts galvanized and/or powder coated RAL 1012
- Standard housing made of polyamide
- Screw connections:
 - Internal thread in the mounting flange for M 25 x 1.5
 - Passage holes in the lower part of the housing for M 25 x 1.5 and M 32 x 1.5

Options

- On request (see "Options", page 5)

²⁾ See page 5, footnote 2)

Order example:

GS45/2KS-04
Encapsulated slip ring assembly type 45/2 with plastic housing, 3-pole + PE

¹⁾ Note: The information on current carrying capacity refers to individual slip rings including current collectors. The actual current carrying capacity of the complete slip ring assembly may differ significantly depending on the prevailing conditions (e.g. number of slip rings, conductivity type, ambient temperature). The corresponding conversion factors for current carrying capacity according to DIN VDE 0298-4 must be taken into account.

Slip Ring Assembly

Built-in Slip Ring Assembly ES18 21 A ¹⁾/690 V (630 V)²⁾



Electrical data

- Voltage:
 - Max. 690 V (630 V)²⁾ ~
 - According to DIN VDE 0110
 - Overvoltage category III
 - Contamination degree 3
- Current: mA to 21A¹⁾, at max. 30°C and 100% duty cycle
- Slip rings:
 - Ø 102 mm, brass (MS)
 - Ring distance 15 mm
- Current collector:
 - Holder with contact spring and three bronze carbon rivets (Br)
 - Connection: Crimping cable lug (DIN46237, ring shape or insulated flat plug receptacle 6.3 DIN46245)
- Protection class: IP 00

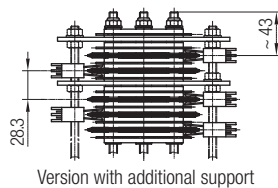
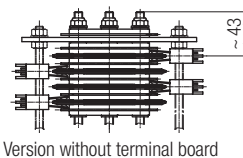
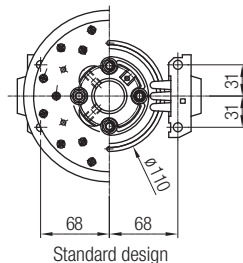
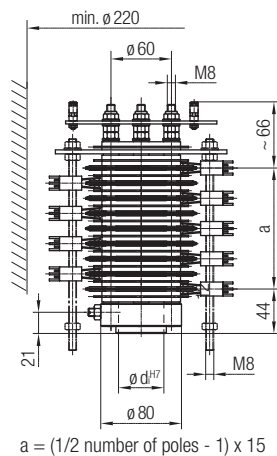

Control and data transmission

- Ring with multi-layer coating (ML) and silver current collector (Ag) for transmission of analog and digital signals
- We ask for a separate request for transmission of indicated values and video signals

Wiring and max. number of poles

- Standard version:
 - Up to 4 rings without terminal board
 - 6 to 36 rings on terminal board with 2.5 mm²
 - From 37 to 48 rings without terminal board with strand wiring 1.5 mm², 2 m from flange
 - From 10 rings with support disk
 - From 48 rings with intermediate support
- Special version:
 - Up to 25 rings on terminal board with 4 mm²
 - Up to 48 rings on terminal board with 1.5 mm² possible
 - Up to max. 100 rings without terminal board with strand wiring 1 mm², 2 m from flange

Further technical data

- Rotation speed for
 - Standard version (MS rings and Br-current collectors): 1-100 min⁻¹
 - Data (ML rings and Ag current collector): 1-30 min⁻¹
- Insulation: Insulating parts polyamide, glass fiber reinforced
- Ambient temperature:
 - From -30°C to max. +50°C
 - At > 30°C, the max. current load must be reduced accordingly
 - Higher temperature values on request
- Installation position: upright (other installation positions on request)
- Flange diameter: d_f
 - 45^{H8}
 - 20^{H8}, 30^{H8} and 35^{H8} on request

Scope of delivery

- Slip Ring Assembly without brush bolt
- Current collector supplied loose
- Possible on request with brush bolts

²⁾ See page 5, footnote 2)

Order example:
ES18/F45-24
 Built-in slip ring assembly
 Type 18, 23-pole + PE
 Flange diameter
 d_f^{H8} = 45^{H8}

¹⁾ Note: The information on current carrying capacity refers to individual slip rings including current collectors. The actual current carrying capacity of the complete slip ring assembly may differ significantly depending on the prevailing conditions (e.g. number of slip rings, conductivity type, ambient temperature). The corresponding conversion factors for current carrying capacity according to DIN VDE 0298-4 must be taken into account.

Slip Ring Assembly

Encapsulated Slip Ring Assembly GS18 21 A¹⁾/690 V (630 V)²⁾

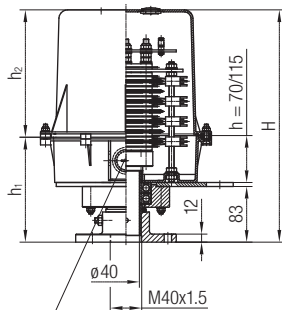

$h_{70} = 1 \times M32 \times 1.5 + 1 \times M25 \times 1.5$
 $h_{115} = 1 \times M40 \times 1.5 + 1 \times M25 \times 1.5$

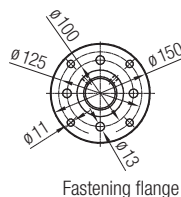
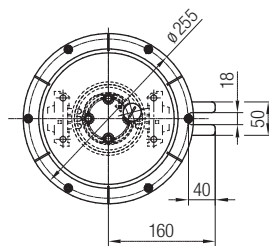

Fastening flange

Electrical data

- Voltage:
 - Max. 690 V (630 V)²⁾ ~ =
 - According to DIN VDE 0110
 - Overvoltage category III
 - Insulating material group II / III
 - Contamination degree 3
- Current: mA to 21 A¹⁾, at max. 30°C and 100% duty cycle
- Slip rings:
 - \varnothing 102 mm, brass (MS)
 - Ring distance 15 mm
- Current collector:
 - Holder with two contact springs and three bronze carbon rivets each (Br)
 - Connection: Crimping cable lug (DIN 46237, ring shape or insulated flat plug receptacle 6.3 DIN 46245)
- Protection class: IP65

h_1 [mm]	h_2 [mm]	H [mm]	Max. number of poles	
			Incl. PE	with heating
157	125	282	10	-
	190	347	18	8
	280	437	30	20
202	125	327	14	6
	190	392	24	14
	280	482	36	26

Control and data transmission

- Ring with multi-layer coating (ML) and silver current collector (Ag) for transmission of analog and digital signals
- We ask for a separate request for transmission of indicated values and video signals

Scope of delivery

- Standard without screw connections
- Possible on request with metric screw connections

Options

- On request (see "Options", page 5)

Wiring and max. number of poles

- Standard version:
 - Up to 36 rings on terminal board with 2.5 mm²
 - From 37 to 48 rings without terminal board with strand wiring 1.5 mm², 2 m from flange
 - From 10 rings with support disk
 - From 48 rings with intermediate support
- Special version:
 - Up to 25 rings on terminal board with 4 mm²
 - Up to 48 rings on terminal board with 1.5 mm² possible
 - Up to max. 100 rings without terminal board with strand wiring 1 mm², 2 m from flange

Further technical data

- Rotation speed for
 - Standard version (MS rings and Br-current collectors): 1-100 min⁻¹
 - Data (ML rings and Ag current consumers): 1-30 min⁻¹
- Storage: Rolling bearings, lubricated for life
 - Ambient temperature:
 - From -30°C to max. +50°C
 - At > 30°C, the max. current load must be reduced accordingly
 - Higher temperature values on request
- Installation position: upright (other installation positions on request)
- Corrosion protection:
 - Steel parts galvanized and/or powder coated
 - Aluminum (powder coated)
 - Standard housing made of polyamide, up to 36 poles
 - From 37 poles, steel housing (IP 54)

²⁾ See page 5, footnote 2)

Order example:
GS18KS-24/08ML/LI
 Encapsulated slip ring assembly
 type 18, 23-pole + PE 8
 multi-layer coated strand wiring

¹⁾ Note: The information on current carrying capacity refers to individual slip rings including current collectors. The actual current carrying capacity of the complete slip ring assembly may differ significantly depending on the prevailing conditions (e.g. number of slip rings, conductivity type, ambient temperature). The corresponding conversion factors for current carrying capacity according to DIN VDE 0298-4 must be taken into account.

Slip Ring Assembly

Built-in Slip Ring Assembly ES13 50 A¹⁾/690 V (630 V)²⁾

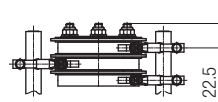
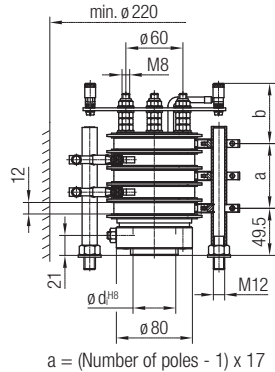

Version with strand wiring

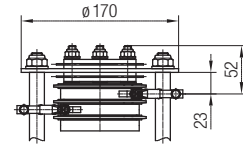

Version with support disk for 8 rings

Electrical data

- Voltage:
 - Max. 690 V (630 V)²⁾~
 - According to DIN VDE 0110
 - Overvoltage category III
 - Contamination degree 3
- Current: 50 A¹⁾, at max. 30°C and 100% duty cycle
- Slip rings:
 - ø 85 x 12 mm, brass (MS)
 - Ring distance 17 mm
 - Connection M 6
- Current collector:
 - Industrial double holder with two moveable carbon-fiber brushes (Cu) 22 x 6.4 mm
 - Connection M 5
- Protection class: IP 00

Rings	b [mm]
Up to 7	63
From 8	90

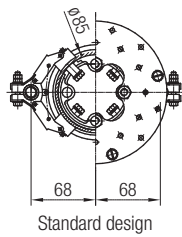

Wiring and max. number of poles

- Max. 28 (including PE) completely wired with 10 mm²
- Up to 14 poles on terminal board, connection to sheath clamps
- Strand wiring 10 mm² to 28 rings possible
- Versions from 8 rings with intermediate support (supporting disk)

Scope of delivery

- With current collector
- Without brush bolt
- Installation position: upright (other installation positions on request)
- Flange diameter d_i:
 - 45^{H8}
 - 20^{H8}, 30^{H8}, 35^{H8} on request

Further technical data

- Rotation speed: 1-100 min⁻¹
- Ambient temperature:
 - From -30°C to max. +50°C
 - At > 30°C, the max. current load must be reduced accordingly
 - Higher temperature values on request

²⁾ See page 5, footnote 2)

Order example:

ES13/F45-04
Built-in slip ring assembly type 13, 3-pole + PE, flange diameter d_i = 45^{H8}

Encapsulated Slip Ring Assembly GS13 50 A¹⁾/690 V (630 V)²⁾

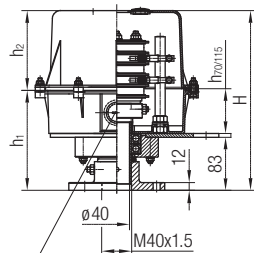

$$h_{70} = 1 \times M32 \times 1.5 + 1 \times M25 \times 1.5$$

$$h_{115} = 1 \times M40 \times 1.5 + 1 \times M25 \times 1.5$$

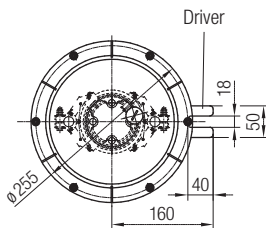

h ₁ [mm]	h ₂ [mm]	H [mm]	Max. number of poles			
			A	B	C	D
157	125	282	6	4	-	-
	190	347	8	7	5	3
	280	437	14	11	9	7
202	125	327	7	6	4	2
	190	392	11	8	7	6
	280	482	16	14	12	10

- A) Without terminal board;
- B) With terminal board;
- C) Without terminal board with heating;
- D) With terminal board and heating

Electrical data

- According to type ES13
- Protection class: IP 65

Wiring and max. number of poles

- According to type ES13

¹⁾ Note: The information on current carrying capacity refers to individual slip rings including current collectors. The actual current carrying capacity of the complete slip ring assembly may differ significantly depending on the prevailing conditions (e.g. number of slip rings, conductivity type, ambient temperature). The corresponding conversion factors for current carrying capacity according to DIN VDE 0298-4 must be taken into account.

Further technical data

- Rotation speed: 1-100 min⁻¹
- Ambient temperature:
 - From -30°C to max. +50°C
 - At > 30°C, the max. current load must be reduced accordingly
 - Higher temperature values on request
- Installation position: upright (other installation positions on request)
- Storage: Rolling bearings, lubricated for life
- Corrosion protection:
 - Steel parts galvanized and/or powder coated RAL 1012
 - Aluminum (powder coated)

- Standard housing made of polyamide, up to 16 poles
- From 17 rings with steel housing IP54

Options

- On request (see "Options", page 5)

²⁾ See page 5, footnote 2)

Scope of delivery

- Standard without screw connections
- On request with metric screw connections possible

Order example

GS13KS-04
Encapsulated slip ring assembly type 13 with plastic housing; 3-pole + PE

Slip Ring Assembly

Built-in Slip Ring Assembly ES15 70 A (90 A)^{1) 4)} / 690 V (630 V)²⁾

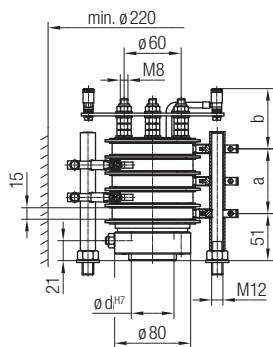

$$a = (\text{Number of poles} - 1) \times 20$$

Rings	b [mm]
up to 7	65
8 / 16	91

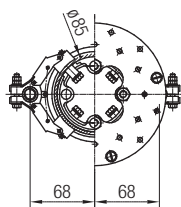

Standard design

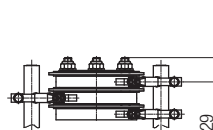

Version with strand wiring

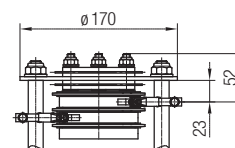

Version with support disk for 8 rings

Electrical data

- Voltage:
 - Max. 690 V (630 V)^{2) ~}
 - According to DIN VDE 0110
 - Overvoltage category III
 - Contamination degree 3
- Current: 70 A (90 A)^{1) 4)}, at max. 30°C and 100% duty cycle
- Slip rings:
 - $\varnothing 85 \times 15$ mm, brass (MS)
 - Ring distance 20 mm
 - Connection M 8
- Current collector:
 - Industrial double holder with two moveable carbon-fiber brushes (Cu) 25 x 8 mm
 - Connection M 6
- Protection class: IP 00

Wiring and max. number of poles

- Max. 16 (including PE) completely wired with 16 mm²
- Up to 8 poles on terminal board, connection to sheath clamps
- Strand wiring 16 mm² to 16 rings possible
- Versions from 8 rings with intermediate support (supporting disk)

Further technical data

- Rotation speed: 1-100 min⁻¹
- Ambient temperature:
 - From -30°C to max. +50°C
 - At > 30°C, the max. current load must be reduced accordingly
 - Higher temperature values on request

- Installation position: upright (other installation positions on request)
- Flange diameter d:
 - 45^{H8}
 - 20^{H8}, 30^{H8}, 35^{H8} on request

2) See page 5, footnote 2)

4) 90 A special on request with 25 mm² wired

Order example: ES15/F45-04

Built-in slip ring assembly type 15, 3-pole + PE, flange diameter d₁ = 45^{H8}

Encapsulated Slip Ring Assembly GS15 70 A (90 A)^{1) 4)} / 690 V (630 V)²⁾

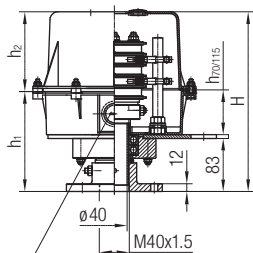

$$h_{70} = 1 \times M32 \times 1.5 + 1 \times M25 \times 1.5$$

$$h_{115} = 1 \times M40 \times 1.5 + 1 \times M25 \times 1.5$$

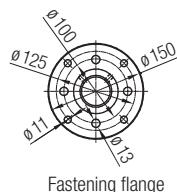
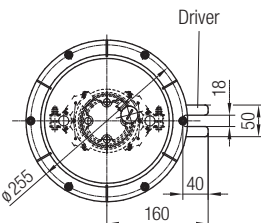

Fastening flange

Electrical data

- According to type ES15
- Protection class: IP 65

Wiring and max. number of poles

- According to type ES15

h ₁ [mm]	h ₂ [mm]	H [mm]	Max. number of poles			
			A	B	C	D
157	125	282	5	3	-	-
	190	347	-	6	4	3
	280	437	11	9	7	7
202	125	327	7	5	3	2
	190	392	9	7	7	5
	280	482	14	8	9	8

A) Without terminal board;

B) With terminal board;

C) Without terminal board with heating;

D) With terminal board and heating

Further technical data

- Rotation speed: 1-100 min⁻¹
- Ambient temperature:
 - From -30°C to max. +50°C
 - At > 30°C, the max. current load must be reduced accordingly
 - Higher temperature values on request
- Installation position: upright (other installation positions on request)
- Storage: Rolling bearings, lubricated for life
- Corrosion protection:
 - Steel parts galvanized and/or powder coated
 - Aluminum (powder coated)
 - Standard polyamide housing (up to 13 rings)
 - 14 - 16 rings with steel housing IP54

Scope of delivery

- Standard without fittings
- Possible on request with metric screw connections

Options

- On request (see "Options", page 5)

2) See page 5, footnote 2)

4) 90 A special on request with 25 mm² wired

Order example: GS15KS-04

Encapsulated slip ring assembly type 15 with plastic housing; 3-pole + PE

¹⁾ Note: The information on current carrying capacity refers to individual slip rings including current collectors. The actual current carrying capacity of the complete slip ring assembly may differ significantly depending on the prevailing conditions (e.g. number of slip rings, conductivity type, ambient temperature). The corresponding conversion factors for current carrying capacity according to DIN VDE 0298-4 must be taken into account.

Slip Ring Assembly

Built-in Slip Ring Assembly ES16 100 A¹⁾/750 V (1000 V on request)



Electrical data

- Voltage:
 - Max. 750V⁵⁾ ~ =
 - According to DIN VDE 0110
 - Overvoltage category IV
 - Contamination degree 3
- Current: 100 A¹⁾, at max. 30°C and 100% duty cycle
- Slip rings:
 - \varnothing 110 x 14 mm, brass (MS)
 - Ring distance 29 mm
 - Connection M 8
- Current collector:
 - Industrial double holder with two moveable carbon-fiber brushes (Cu) 32 x 10 mm
 - Connection M 8
- Protection class: IP 00

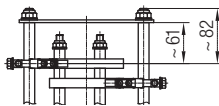
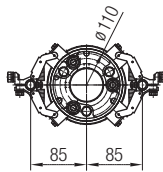
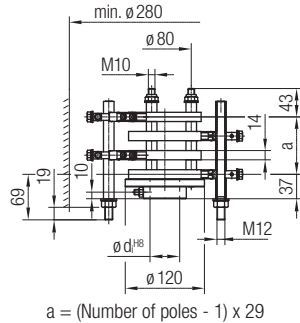

For 5 poles with connecting bracket

Wiring and max. number of poles

- Max. 12 (including PE), customer connection with 35 mm²
- Strand wiring 25 mm², on request
- From 5 rings with connecting bracket

Further technical data

- Rotation speed: 1-100 min⁻¹
- Ambient temperature:
 - From -30°C to max. +60°C
 - At > 30°C, the max. current load must be reduced accordingly
 - Higher temperature values on request
- Installation position: upright (other installation positions on request)
- Flange diameter d_i:
 - 45^{H8}
 - 35^{H8} on request

Scope of delivery

- With current collector and insulating tube
- Without brush bolt

⁵⁾ 1000 V on request

Order example: ES16/F45-04

Built-in slip ring assembly type 16, 3-pole + PE, flange diameter d_i = 45^{H8}

Encapsulated Slip Ring Assembly GS16 100 A¹⁾/750 V (1000 V on request)



Electrical data

- According to type ES16
- Protection class: IP 54

Wiring and max. number of poles

- Max. 9 (including PE)
- Otherwise like type ES16

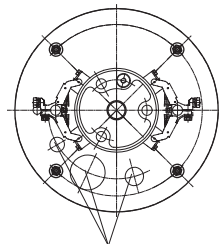
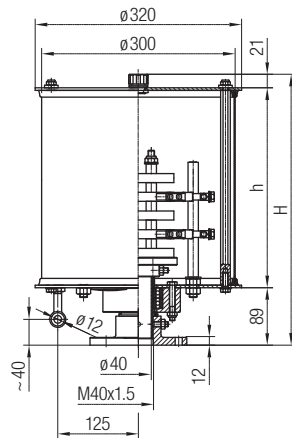

Bore holes in the floor panel intended for the following screw connections:
 1x M50x1.5
 1x M25x1.5
 1x M20x1.5

Scope of delivery

- Standard without screw connections
- On request with metric screw connections

Options

- On request (see "Options", page 5)

Further technical data

- Rotation speed: 1-100 min⁻¹
- Ambient temperature:
 - From -30°C to max. +60°C
 - At > 30°C, the max. current load must be reduced accordingly
 - Higher temperature values on request
- Installation position: upright (other installation positions on request)
- Storage: Rolling bearings, lubricated for life
- Corrosion protection: Steel parts galvanized and/or powder coated
 - Aluminum parts: powder-coated
- Protective cover:
 - Removable upwards
 - Also split on request, i.e. removable from the side (protection type IP 54)

Order example: GS16-04

Encapsulated slip ring assembly type 16 with steel housing; 3-pole + PE

¹⁾ Note: The information on current carrying capacity refers to individual slip rings including current collectors. The actual current carrying capacity of the complete slip ring assembly may differ significantly depending on the prevailing conditions (e.g. number of slip rings, conductivity type, ambient temperature). The corresponding conversion factors for current carrying capacity according to DIN VDE 0298-4 must be taken into account.

Slip Ring Assembly

Built-in Slip Ring Assembly ES19 150 A¹⁾/750 V (1000 V on request)

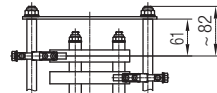
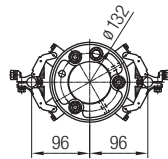
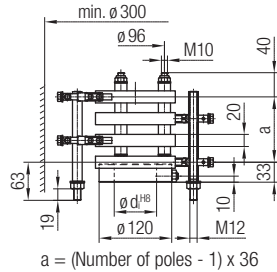

For 5 poles with connecting bracket

Electrical data

- Voltage:
 - Max. 750V⁵⁾ ~ =
 - According to DIN VDE 0110
 - Overvoltage category IV
 - Contamination degree 3
- Current: 150 A¹⁾, at max. 30°C and 100% duty cycle
- Slip rings:
 - ø 132 x 20 mm, brass (MS)
 - Ring distance 36 mm
 - Connection M 8
- Current collector:
 - Industrial double holder with two moveable carbon-fiber brushes (Cu) 32 x 10 mm
 - Connection M 8
- Protection class: IP 00

Wiring and max. number of poles

- Max. 18 (including PE), customer connection with 35 mm²
- Strand wiring 35 mm², on request
- From 5 rings with connecting bracket

Further technical data

- Rotation speed: 1-100 min⁻¹
- Ambient temperature:
 - From -30°C to max. +60°C
 - At > 30°C, the max. current load must be reduced accordingly
 - Higher temperature values on request
- Installation position: upright (other installation positions on request)
- Flange diameter d_i:
 - 70^{H8}
 - 35^{H8} and 45^{H8} on request

Scope of delivery

- With current collector and insulating tube
- Without brush bolt

⁵⁾ 1000 V on request

Order example: ES19/F70-04

Built-in slip ring assembly type 19, 3-pole + PE, flange diameter d_i = 70^{H8}

Encapsulated Slip Ring Assembly GS19 150 A¹⁾/750 V (1000 V on request)

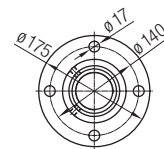
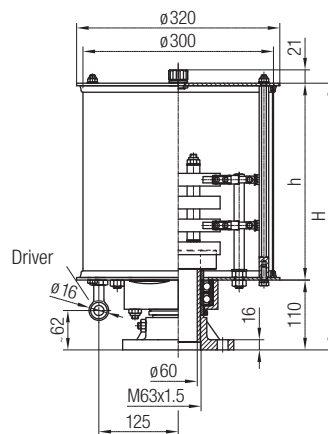

Fastening flange

Electrical data

- According to type ES19
- Protection class: IP 54

Wiring and max. number of poles

- Max. 16
- Otherwise like type ES19

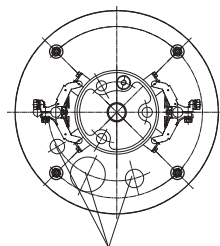

Bore holes in the floor panel intended for the following screw connections:
 1x M50x1.5
 1x M25x1.5
 1x M20x1.5

Further technical data

- Rotation speed: 1-100 min⁻¹
- Ambient temperature:
 - From -30°C to max. +60°C
 - At > 30°C, the max. current load must be reduced accordingly
 - Higher temperature values on request
- Installation position: upright (other installation positions on request)
- Storage: Rolling bearings, lubricated for life
- Corrosion protection: Steel parts galvanized and/or powder coated
 - Aluminum parts: powder-coated
- Protective cover:
 - Removable upwards
 - Also split on request, i.e. removable from the side (protection type IP 54)

Scope of delivery

- Standard without screw connections
- On request with metric screw connections

Options

- On request (see "Options", page 5)

Order example: GS19-04

Encapsulated slip ring assembly type 19 with steel housing; 3-pole + PE

¹⁾ Note: The information on current carrying capacity refers to individual slip rings including current collectors. The actual current carrying capacity of the complete slip ring assembly may differ significantly depending on the prevailing conditions (e.g. number of slip rings, conductivity type, ambient temperature). The corresponding conversion factors for current carrying capacity according to DIN VDE 0298-4 must be taken into account.

Slip Ring Assembly

Built-in Slip Ring Assembly ES21 250 A¹⁾/750 V (1000 V on request)



Electrical data

- Voltage:
 - Max. 750V⁵⁾ =
 - According to DIN VDE 0110
 - Overvoltage category IV
 - Contamination degree 3
- Current: 250 A¹⁾, at max. 30°C and 100% duty cycle
- Slip rings:
 - \varnothing 210 x 25 mm, brass (MS)
 - Ring distance 44 mm
 - Connection M 10 / M 12
- Current collector:
 - Industrial double holder with two moveable carbon-fiber brushes (Cu) 45 x 16 mm
 - Connection M 10
- Protection class: IP 00

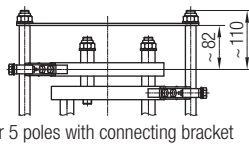
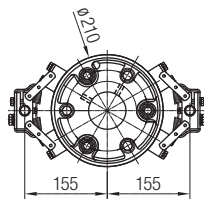
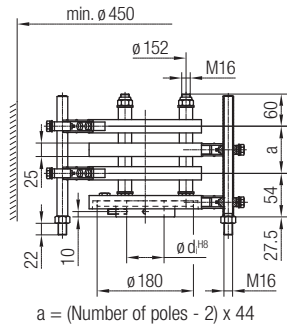

Wiring and max. number of poles

- Max. 8 (including PE), customer connection with 95 mm²
- Strand wiring 95 mm², on request
- From 5 rings with connecting bracket

Further technical data

- Rotation speed: 1-100 min⁻¹
- Ambient temperature:
 - From -30°C to max. +60°C
 - At > 30°C, the max. current load must be reduced accordingly
 - Higher temperature values on request
- Installation position: upright (other installation positions on request)
- Flange diameter d_f: 70^{H8}

Scope of delivery

- Slip Ring Assembly complete with brush pins and current collectors
- Insulating tube

⁵⁾ 1000 V on request

Order example: ES21/F70-04
Built-in slip ring assembly type 21, 3-pole + PE, flange diameter d_f = 70^{H8}

Encapsulated Slip Ring Assembly GS21 250 A¹⁾/750 V (1000 V on request)



Electrical data

- According to type ES21
- Protection class: IP 54

Wiring and max. number of poles

- Like type ES21

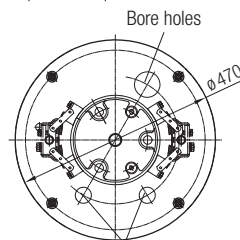
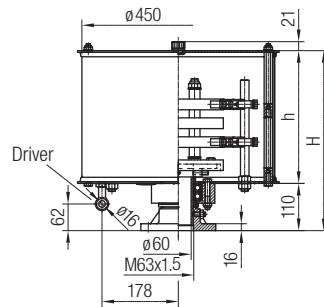

Bore holes in the floor panel intended for the following screw connections:
1x M63x1.5, 1x M40x1.5, 1x M32x1.5

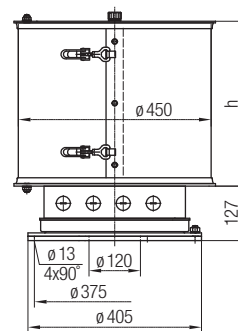

Storage:

- Rolling bearings, lubricated for life
- Ball bearing turntable (on request)
- Corrosion protection: Steel parts galvanized and/or powder coated
- Aluminum parts: powder-coated
- Protective cover:
 - Removable upwards
 - Also split on request, i.e. removable from the side (degree of protection IP 54)

Scope of delivery

- Standard without screw connections
- On request with metric screw connections

Options

- On request (see "Options", page 5)

Further technical data

- Rotation speed: 1-100 min⁻¹
- Ambient temperature:
 - From -30°C to max. +60°C
 - At > 30°C, the max. current load must be reduced accordingly
 - Higher temperature values on request
- Installation position: upright (other installation positions on request)

Order example: GS21-04
Encapsulated slip ring assembly type 21 with steel housing; 3-pole + PE

¹⁾ Note: The information on current carrying capacity refers to individual slip rings including current collectors. The actual current carrying capacity of the complete slip ring assembly may differ significantly depending on the prevailing conditions (e.g. number of slip rings, conductivity type, ambient temperature). The corresponding conversion factors for current carrying capacity according to DIN VDE 0298-4 must be taken into account.

Slip Ring Assembly

Built-in Slip Ring Assembly ES29 400 A¹⁾/750 V (1000 V on request)



Electrical data

- Voltage:
 - Max. 750V⁵⁾ ~ =
 - According to DIN VDE 0110
 - Overvoltage category IV
 - Insulating material group II
 - Contamination degree 3
- Current: 400 A, at max. 30°C and 100% duty cycle
- Slip rings:
 - \varnothing 210 x 25 mm, brass (MS)
 - Ring distance 44 mm
 - Connection M 12
- Current collector phase:
 - Industrial double holder with two moveable carbon-fiber brushes (Cu) 50 x 20 mm
 - Connection M 12

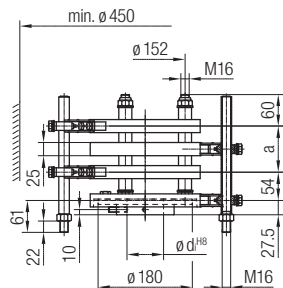

$$a = (\text{Number of poles} - 2) \times 44$$

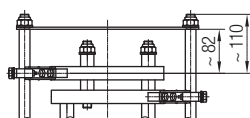
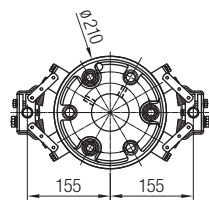

For 5 poles with connecting bracket

- Current collector PE: like phase, but carbon-fiber brush 45 x 16, max. 300 A
- Protection class: IP 00

Wiring and max. number of poles

- Max. 4 (including PE), customer connection with 2 x 95 mm²
- Strand wiring 2 x 95 mm², on request
- From 5 rings with connecting bracket

Further technical data

- Rotation speed: 1-100 min⁻¹
- Ambient temperature:
 - From -30°C to max. +60°C
 - At > 30°C, the max. current load must be reduced accordingly
 - Higher temperature values on request
- Installation position: upright (other installation positions on request)
- Flange diameter d_i: 70^{H8}

Scope of delivery

- Slip Ring Assembly complete with brush pins and current collectors
- Insulating tube

⁵⁾ 1000 V on request

Order example:

ES29 / F70-04
Built-in slip ring assembly type 29, 3-pole + PE, flange diameter d_i = 70^{H8}

Encapsulated Slip Ring Assembly GS29 400 A¹⁾/750 V (1000 V on request)



Electrical data

- According to type ES29
- Protection class: IP 54

Wiring and max. number of poles

According to type ES29

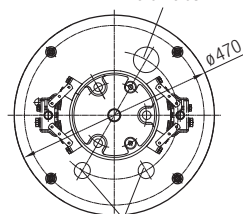
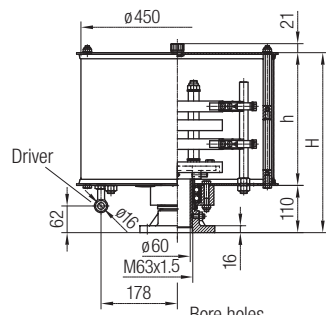

Bore holes in the floor panel intended for the following screw connections:
1x M63x1.5, 1x M40x1.5, 1x M32x1.5

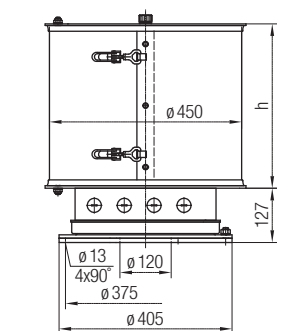

With ball bearing turntable and split cover

- Storage:
 - Rolling bearings, lubricated for life
 - Relubricatable ball bearing turntable (on request)
- Corrosion protection: Steel parts galvanized and/or powder coated
- Aluminum parts: powder-coated
- Protective cover:
 - Removable upwards
 - Also split on request, i.e. removable from the side (degree of protection IP 54)

Scope of delivery

- Standard without fittings
- On request with metric screw connections

Options

- On request (see "Options", page 5)

Further technical data

- Rotation speed: 1-100 min⁻¹
- Ambient temperature:
 - From -30°C to max. +60°C
 - At > 30°C, the max. current load must be reduced accordingly
 - Higher temperature values on request
- Installation position: upright (other installation positions on request)

⁵⁾ 1000 V on request

Order example:

GS29-04
Encapsulated slip ring assembly type 29 with steel housing; 3-pole + PE

¹⁾ Note: The information on current carrying capacity refers to individual slip rings including current collectors. The actual current carrying capacity of the complete slip ring assembly may differ significantly depending on the prevailing conditions (e.g. number of slip rings, conductivity type, ambient temperature). The corresponding conversion factors for current carrying capacity according to DIN VDE 0298-4 must be taken into account.

Slip Ring Assembly

Built-in Slip Ring Assembly ES170, ES200, ES285 47 A¹⁾/690 V (630 V)²⁾

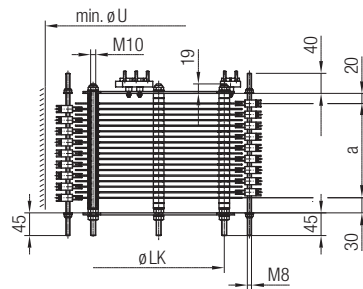

$$a = (\text{Number of poles} - 1) \times 11$$

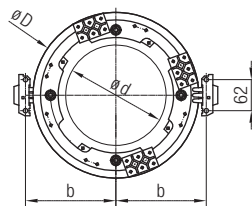

Type	b [mm]	ø d [mm]	ø D [mm]	ø LK [mm]	ø U [mm]	Combination with
ES170	101	75	170	120 – 3 x 120°	290	-
ES200	116	100	200	150 – 3 x 120°	320	ES185
ES285	158.5	160	285	227 – 4 x 90°	400	ES260

Electrical data

- Voltage:
 - Max. 690 V (630 V)²⁾ ~
 - According to DIN VDE 0110
 - Overvoltage category III
 - Contamination degree 3
- Current: mA up to 47 A¹⁾, at max. 30°C and 100% duty cycle
- Current collector:
 - Holder with contact spring and three bronze carbon rivets (Br)
 - Connection: Crimping cable lug (DIN46237, ring shape or insulated flat plug receptacle 6.3 DIN46245)
- Protection class: IP 00

Control and data transmission

- Ring with multi-layer coating (ML) and silver current collector (Ag) for transmission of analog and digital signals
- We ask for a separate request for transmission of indicated values and video signals

Wiring and max. number of poles

- Max. 18 (including PE) completely wired with 6 mm² on terminal boards
- Strand wiring (number of poles on request)
- Connection to the terminal board M5

Further technical data

- Rotation speed: 1-60 min⁻¹
- Tube passage: see table, diameter d
- Ambient temperature:
 - From -30°C to max. +60°C
 - At > 30°C the max. current load must be reduced accordingly
 - Higher temperature values on request
- Installation position: upright (other installation positions on request)
- Mounting options:
 - With 3 piece threaded bolt M 10
 - The brush bolts M 8 must be screwed on top and bottom by the customer

Scope of delivery

- Slip Ring Assembly with current collectors without brush bolts

²⁾ See page 5, footnote 2)

Order example:
ES170-10
 Built-in slip ring assembly
 type 170, 9-pole + PE

¹⁾ Note: The information on current carrying capacity refers to individual slip rings including current collectors. The actual current carrying capacity of the complete slip ring assembly may differ significantly depending on the prevailing conditions (e.g. number of slip rings, conductivity type, ambient temperature). The corresponding conversion factors for current carrying capacity according to DIN VDE 0298-4 must be taken into account.



Combined Slip Ring Assembly

Encapsulated Slip Ring Assembly GS323 400 A¹⁾/750 V (1000 V on request)

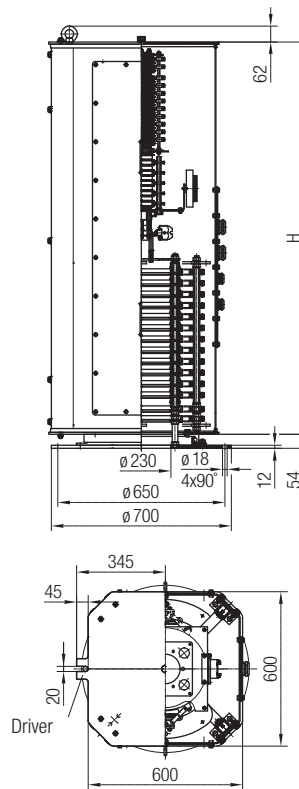

Further technical data

- Rotation speed for
 - Standard version (MS-rings and Br-current collectors): 1-100 min⁻¹
 - Data (ML rings and Ag current collector): 1-30 min⁻¹
- Storage: Relubricatable ball bearing turntable
- Ambient temperature:
 - From -30°C to max. +50°C
 - At > 30°C, the max. current load must be reduced accordingly
 - Higher temperature values on request
- Corrosion protection: Steel parts galvanized and/or powder coated
 - Aluminum parts: powder-coated
 - Stainless steel housing on request
- Installation position: upright

Scope of delivery

- Standard without strand wiring for the main power section
- Depending on the ring structure, metric screw connections are provided as standard or on customer request

Options

- On request (see "Options", page 5)

Electrical data main power section

- Voltage:
 - Max. 750V⁵⁾~ =
 - According to DIN VDE 0110
 - Overvoltage category IV
 - Contamination degree 3
- Current:
 - 400 A¹⁾ at 60% duty cycle
 - Higher currents on request
- General: additional combinations for different currents and voltages are possible
- Protection class: IP 54

Control current section

- As a rule, a type 18 slip ring is used. Technical details can be found on page 12.
- For more information, please contact us.

Control and data transmission

- Ring with multi-layer coating (ML) and silver current collector (Ag) for transmission of analog and digital signals

Wiring

- Control power supply fully wired to terminal block or terminal board
- Main current section on request with strand wiring

⁵⁾ 1000 V on request

We would be happy to discuss further details with you when designing a solution tailored to your needs.

¹⁾ Note: The information on current carrying capacity refers to individual slip rings including current collectors. The actual current carrying capacity of the complete slip ring assembly may differ significantly depending on the prevailing conditions (e.g. number of slip rings, conductivity type, ambient temperature). The corresponding conversion factors for current carrying capacity according to DIN VDE 0298-4 must be taken into account.

Combined Slip Ring Assembly

Encapsulated Slip Ring Assembly e.g. type GS19/13/18

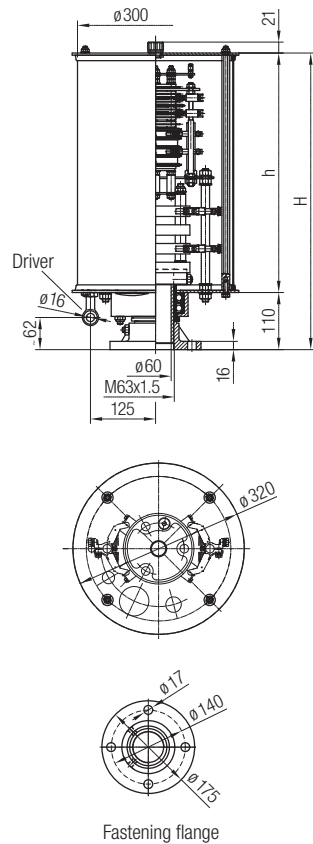

Further technical data

- Rotation speed for
 - Standard version (MS-rings and Br-current collectors): 1-100 min⁻¹
 - Data (ML rings and Ag current collector): 1-30 min⁻¹
- Storage: Rolling bearings, lubricated for life
- Line connection:
 - Main current rings with strand wiring on request
 - Control rings on terminal board, pre-wired
- Protective cover:
 - Removable upwards
 - If desired also split, i.e. removable on side or with viewing or installation window
- Corrosion protection: Steel parts galvanized and/or powder coated
 - Aluminum parts: powder-coated
 - Stainless steel housing on request
- Ambient temperature:
 - From -30°C to max. +50°C
 - At > 30°C, the max. current load must be reduced accordingly
 - Higher temperature values on request
- Installation position: upright (other installation positions on request)

Scope of delivery

- Standard without screw connections
- On request with metric screw connections

Options

- On request (see "Options", page 5)

Electrical data

- Voltage:
 - Max. 690 V (630 V)²⁾~
 - According to DIN VDE 0110
 - Overvoltage category III
 - Contamination degree 3
- Ring structure: 150 A + PE / 50 A / 21 A¹⁾
- Protection class: IP 54

2) See page 5, footnote 2)

We would be happy to discuss further details with you when designing a solution tailored to your needs.

Combined Slip Ring Assembly

Encapsulated Slip Ring Assembly combined with rotary transmitters for gases and fluids

In addition to high-quality slip ring assemblies for power and data transmission, Conductix-Wampfler also has rotary feedthroughs for gases and fluids in its extensive product range. Rotary feedthroughs are used in single and multi-channel designs, sometimes also in combination with slip ring assemblies, on machine tools, on rotary tables, on cranes and in many other industrial applications.

Rotary feedthroughs

- For gases and fluids (except oxygen)
- Single-channel or multi-channel versions
- With and without slip ring assembly for power and data transmission
- For different pressures and temperatures

Combined Slip Ring Assembly type 18 (see page 12) and single-channel rotary feedthroughs for gases and fluids:



We would be happy to discuss further details with you when designing a solution tailored to your needs.

Your Applications – our Solutions

The solutions we deliver for your applications are based on your specific requirements. In many cases, a combination of several different Conductix-Wampfler systems can prove advantageous. You can count on Conductix-Wampfler for hands-on engineering support together with the optimum solution to safely meet your needs.

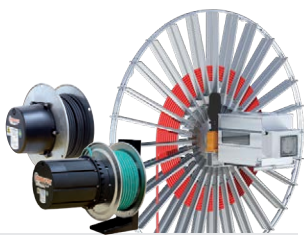

Cable and Hose Reels

Motor driven and spring driven reels by Conductix-Wampfler provide energy, data and media over a variety of distances, in all directions, fast and safe.



Festoon Systems

Conductix-Wampfler cable trolleys can be used in virtually every industrial application. They are reliable, robust and available in an enormous variety of dimensions and designs.

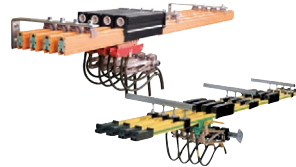

Conductor Rails

Available as enclosed or multiple unipole systems, Conductix-Wampfler conductor rails reliably move people and material.



Inductive Power Transfer

The no-contact system for transferring energy. For all tasks that depend on high speeds and absolute resistance to wear.



Non-insulated Conductor Rails

Robust, non-insulated aluminum conductor rails with stainless steel cap provide the ideal basis for power supply of people movers and transit networks.



Radio Remote Controls

Safety remote control solutions customized to meet our customer needs with modern ergonomic design.



Reels, Retractors and Balancers

Available for hoses and cables, as classical reels or high-precision positioning aids for tools, we offer a complete range of reels and spring balancers.



Jib Booms

Complete with tool transporters, reels or an entire media supply system – safety and flexibility are key to the completion of difficult tasks.



Slip Ring Assemblies

Whenever things are really “moving in circles”, the proven slip ring assemblies by Conductix-Wampfler ensure the flawless transfer of energy and data. Here, everything revolves around flexibility and reliability!



Mobile Control Systems

Mobile control solutions for your plant – whether straightforward or intricate. Control and communication systems from LJU have been tried and tested in the automotive industry for decades.



ProfidAT®

This data transfer system is a compact slotted waveguide that can also be used as grounding rail (PE) at the same time.



Charging Solutions

Whether inductive or conductive, this bundle of products offers always the perfect solution for all industrial charging tasks including the matching battery with integrated battery management system.

www.conductix.com

Conductix-Wampfler

has just one critical mission:

To provide you with energy and data transmission systems that will keep your operations up and running 24/7/365.

To contact your nearest sales office, please refer to:

www.conductix.contact

